

capture flush mount

DESCRIPTION

In the Capture ceiling light from LBL Lighting, a gently diffused orb of LED light is held captive by a band extending from the fixture's sleek, contemporary metal body. Can also be mounted as a wall sconce vertically or horizontally. LED includes 27 watt 1000 lumen 90 CRI 3000K LED module. Dimmable with a low-voltage electronic dimmer. Mounts vertically or horizontally on wall or ceiling.



WEIGHT

3.67lb / 1.66kg ±

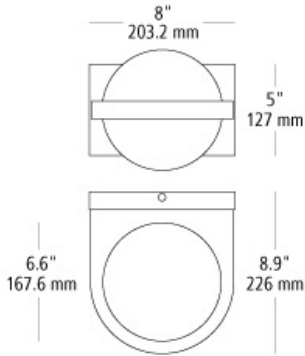

ORDERING INFORMATION

model	color	finish	lamp
FM928	OP opal	SC satin nickel	LED930 LED module 24w 90 CRI 3000K 120v
		WH white	LED930277 LED module 24w 90 CRI 3000K 277v

FIXTURE TYPE: _____
 JOB NAME: _____
 NOTES: _____



7400 Linder Avenue
Skokie, Illinois 60077

T 847.626.6300
F 847.626.6350

www.lblighting.com



©2019 LBL Lighting. All Rights Reserved. The "LBL Lighting" graphic is a registered trademark of LBL Lighting. LBL Lighting reserves the right to change specifications for product improvements without notification.