

REVISIONS			
REV.	DESCRIPTION	DATE	APPROVED
REL-01		7/12/2007	

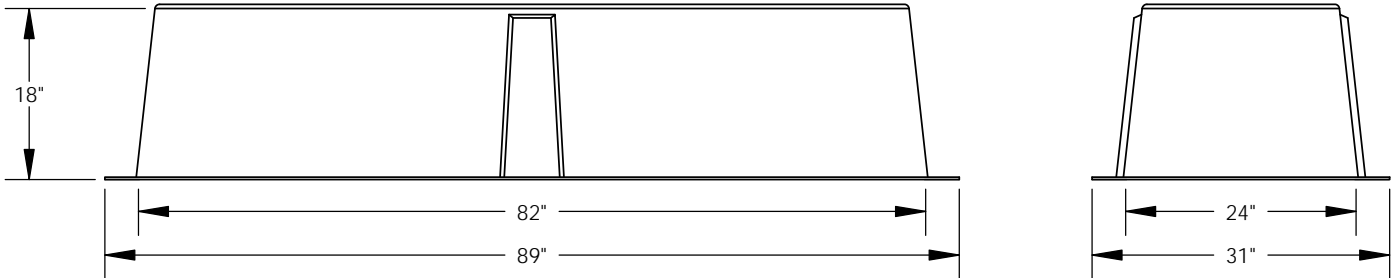
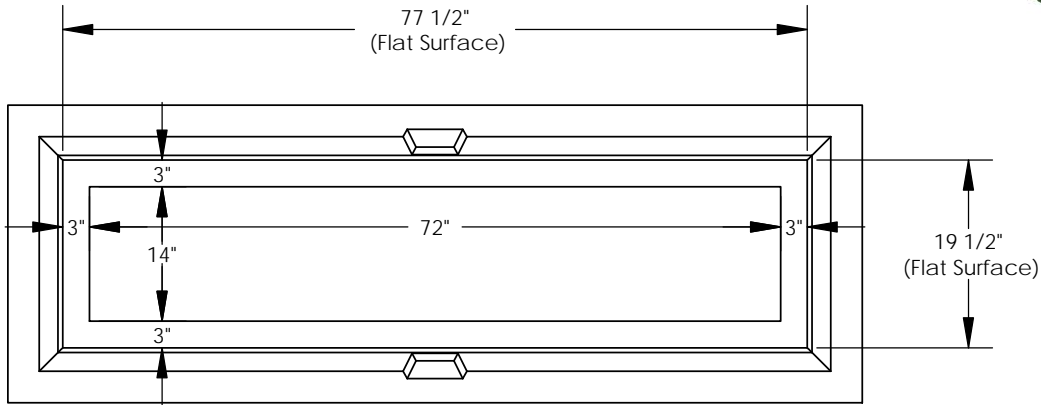
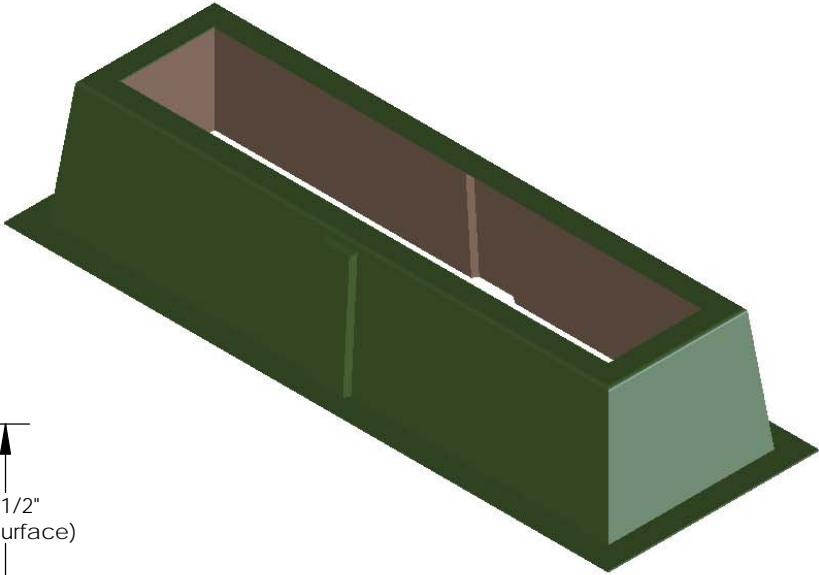

NOTE:
Includes (6) 3/8x1.5 ZN Hex Bolts,
(6) 3/8 ZN Hex Nuts, (12) 3/8 ZN Flat
Washers, (6) 1/2 ZN Flat Washers

Nordic Fiberglass, Inc.

21415 US Hwy 75 NW, Warren, MN 56762
www.nordicfiberglass.com
218-745-5095 ph. --- 218-745-4990 fax

GS-78-20-18-MG-72x14

PROPRIETARY AND CONFIDENTIAL
THE INFORMATION CONTAINED IN THIS DRAWING IS THE SOLE PROPERTY OF
NORDIC FIBERGLASS, INC. ANY REPRODUCTION IN PART OR AS A WHOLE
WITHOUT THE WRITTEN PERMISSION OF NORDIC FIBERGLASS, INC. IS PROHIBITED.

Customer Name: N/A		
DIMENSIONS ARE IN INCHES TOLERANCES: ANGLES $\pm 1^\circ$ FRACTIONAL $\pm 1/2$ ONE PLACE DECIMAL $\pm .060$ TWO PLACE DECIMAL $\pm .030$ THREE PLACE DECIMAL $\pm .015$		
MATERIAL		
	NAME	DATE
DRAWN	P.J.W.	07/12/07
CHECKED	---	--/--/--

SIZE	ITEM ID:	REV.
A	01860.00	REL-01
SCALE: 1:20	SHEET 1 OF 1	