

REVISIONS			
REV.	DESCRIPTION	DATE	APPROVED

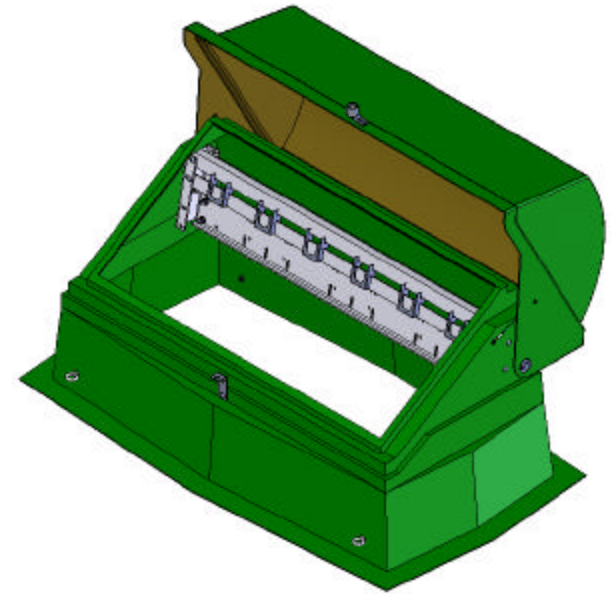

ZN Coated Eyebolt
4x

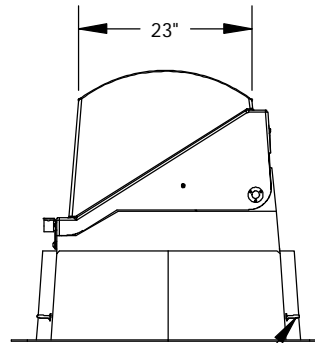
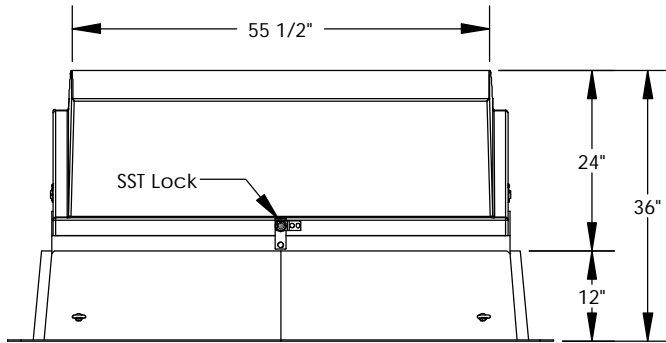
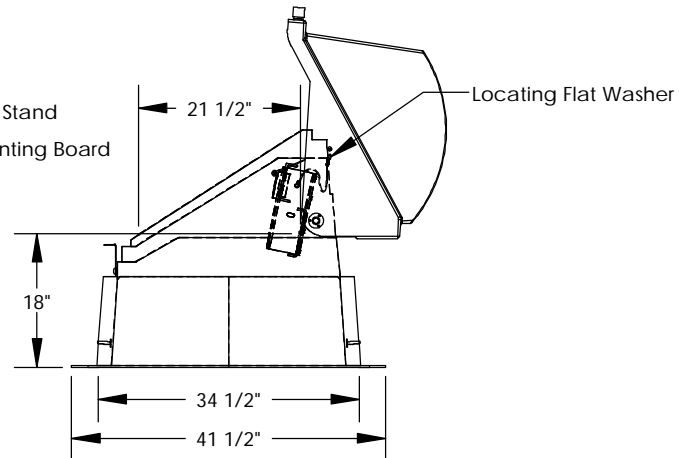
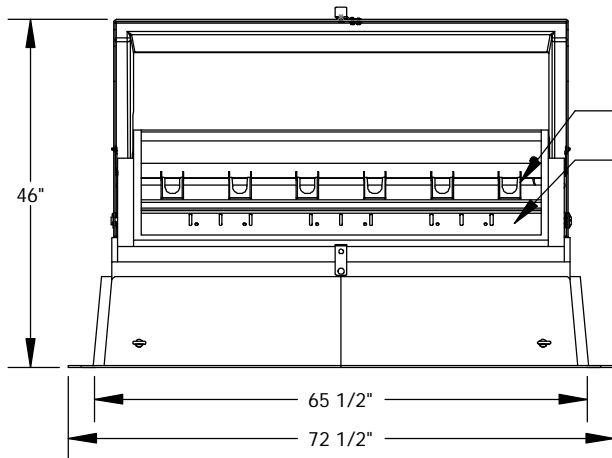

Nordic Fiberglass, Inc.

21415 US Hwy 75 NW, Warren, MN 56762
www.nordicfiberglass.com
218-745-5095 ph. --- 218-745-4990 fax

ND-552436-MG-PA58-X-X

PROPRIETARY AND CONFIDENTIAL
THE INFORMATION CONTAINED IN THIS DRAWING IS THE SOLE PROPERTY OF NORDIC FIBERGLASS, INC. ANY REPRODUCTION IN PART OR AS A WHOLE WITHOUT THE WRITTEN PERMISSION OF NORDIC FIBERGLASS, INC. IS PROHIBITED.

Customer Name: N/A		
DIMENSIONS ARE IN INCHES		
TOLERANCES: ANGLES ± 1°		
FRACTIONAL ± 1/2		
ONE PLACE DECIMAL ± .060		
TWO PLACE DECIMAL ± .030		
THREE PLACE DECIMAL ± .015		
MATERIAL		
DRAWN	NAME	DATE
P.J.W.		11/02/06
CHECKED		

SIZE	ITEM ID:	REV.
A	04021.00	REL-01
SCALE: 1:24		SHEET 1 OF 1