

REVISIONS			
REV.	DESCRIPTION	DATE	APPROVED

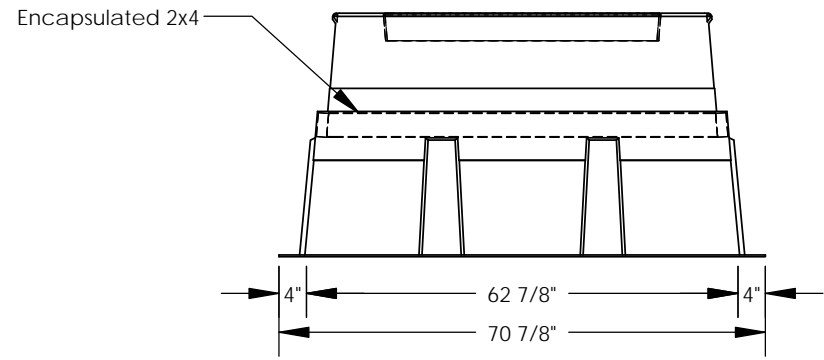
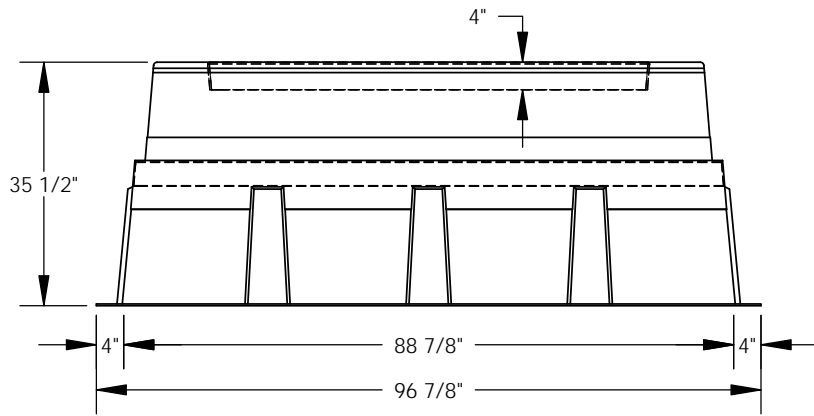
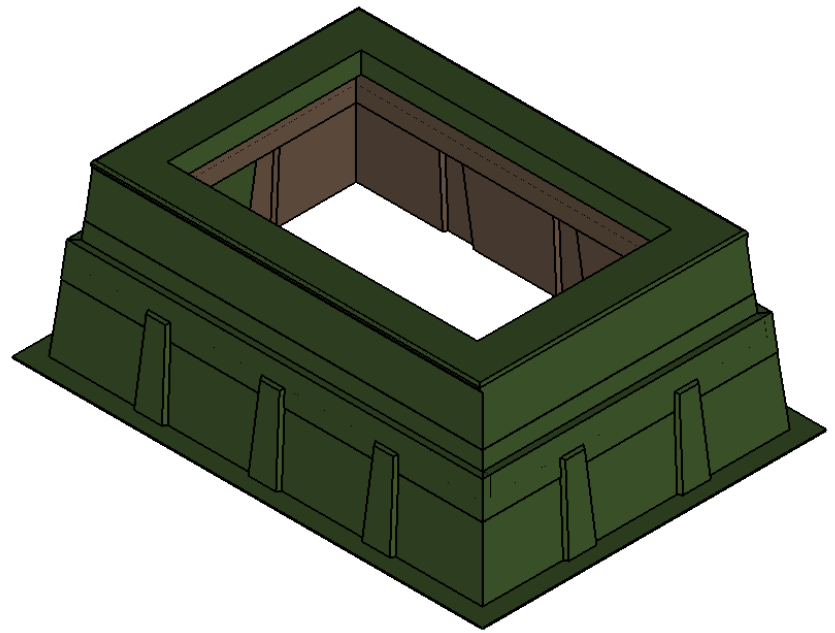
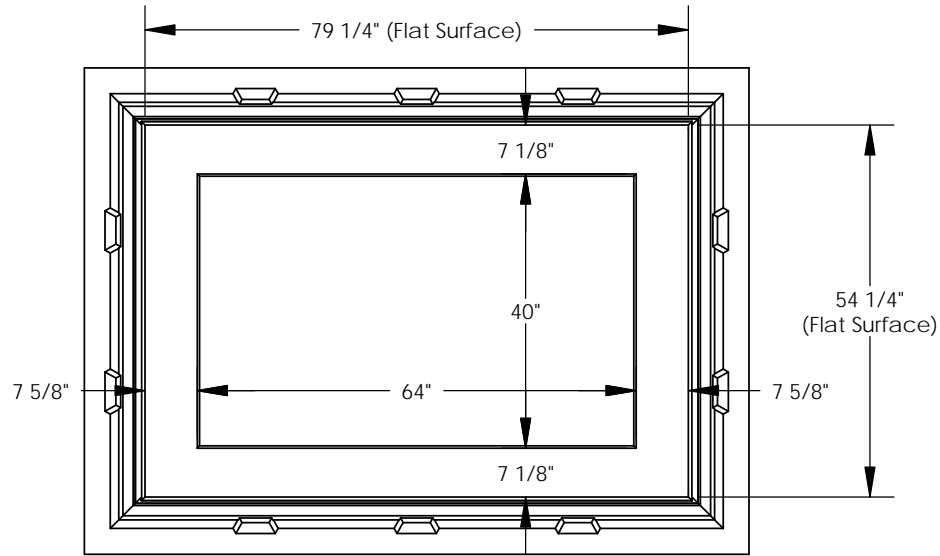

PROPRIETARY AND CONFIDENTIAL
 THE INFORMATION CONTAINED IN THIS DRAWING IS THE SOLE PROPERTY OF NORDIC FIBERGLASS, INC. ANY REPRODUCTION IN PART OR AS A WHOLE WITHOUT THE WRITTEN PERMISSION OF NORDIC FIBERGLASS, INC. IS PROHIBITED.

Customer Name: N/A		
DIMENSIONS ARE IN INCHES TOLERANCES: ANGLES $\pm 1^\circ$ FRACTIONAL $\pm 1/2$ ONE PLACE DECIMAL $\pm .060$ TWO PLACE DECIMAL $\pm .030$ THREE PLACE DECIMAL $\pm .015$		
MATERIAL		
DRAWN	R.L.J.	09/25/15
CHECKED	---	--/--/--

Nordic Fiberglass, Inc.
 21415 US Hwy 75 NW, Warren, MN 56762
 www.nordicfiberglass.com
 218-745-5095 ph. --- 218-745-4990 fax

GS-80-54-36-MG-64x40

SIZE	ITEM ID:	REV.
A	01910.19	REL-01
SCALE:1:4	SHEET 1 OF 1	