

REVISIONS			
REV.	DESCRIPTION	DATE	APPROVED
REL-01		6/5/2007	

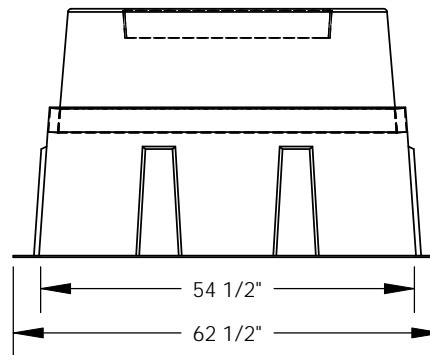
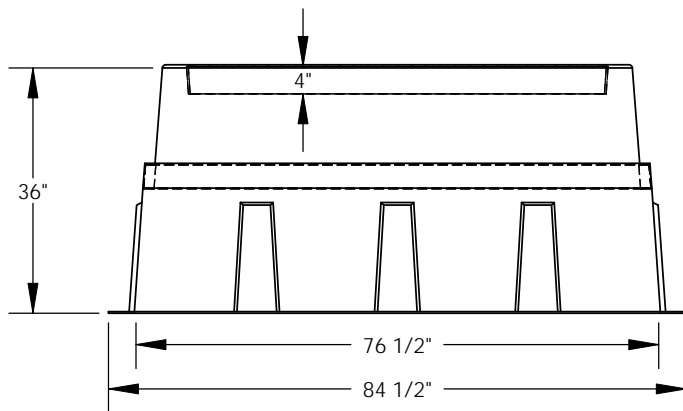
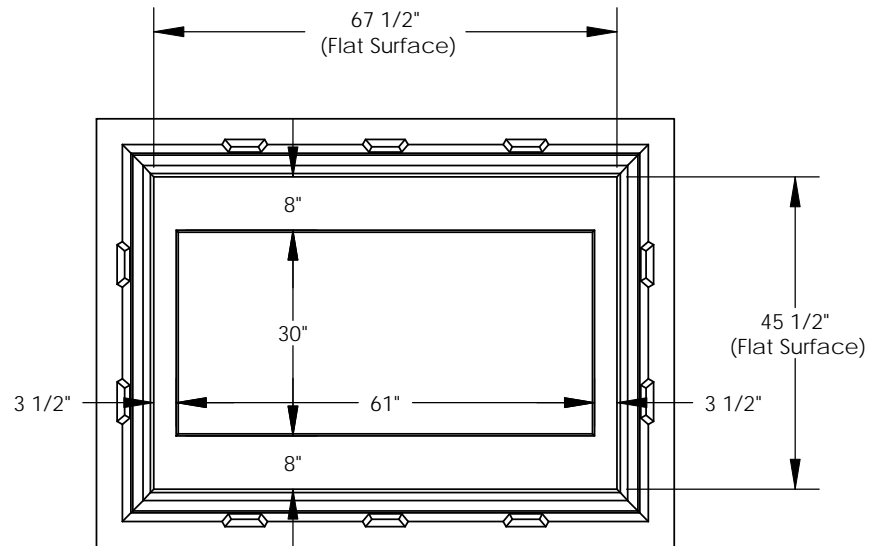
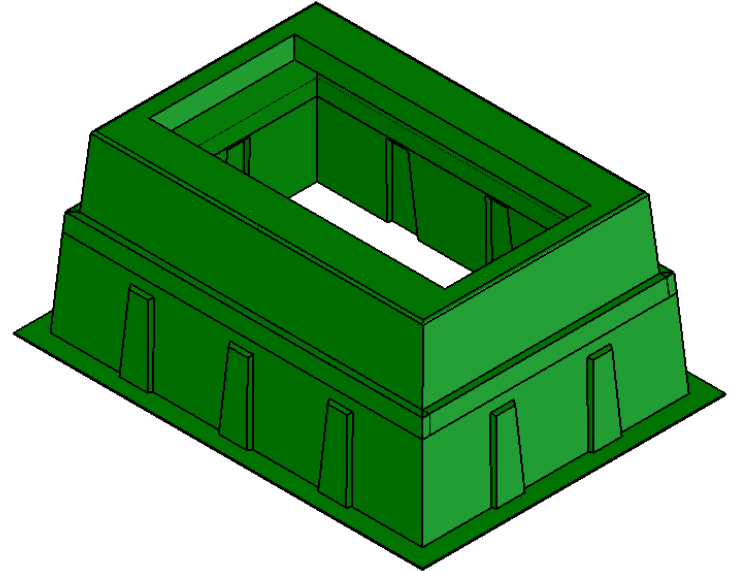

PROPRIETARY AND CONFIDENTIAL
 THE INFORMATION CONTAINED IN THIS DRAWING IS THE SOLE PROPERTY OF NORDIC FIBERGLASS, INC. ANY REPRODUCTION IN PART OR AS A WHOLE WITHOUT THE WRITTEN PERMISSION OF NORDIC FIBERGLASS, INC. IS PROHIBITED.

Customer Name: N/A		
DIMENSIONS ARE IN INCHES		
TOLERANCES: ANGLES $\pm 1^\circ$		
FRACTIONAL $\pm 1/2$		
ONE PLACE DECIMAL $\pm .060$		
TWO PLACE DECIMAL $\pm .030$		
THREE PLACE DECIMAL $\pm .015$		
MATERIAL		
DRAWN	NAME	DATE
	P.J.W.	06/05/07
CHECKED		--/--/--

Nordic Fiberglass, Inc.
 21415 US Hwy 75 NW, Warren, MN 56762
 www.nordicfiberglass.com
 218-745-5095 ph. --- 218-745-4990 fax

GS-69-47-36-MG-61x30

SIZE	ITEM ID:	REV.
A	01570.02	REL-01
SCALE:1:28	SHEET 1 OF 1	