

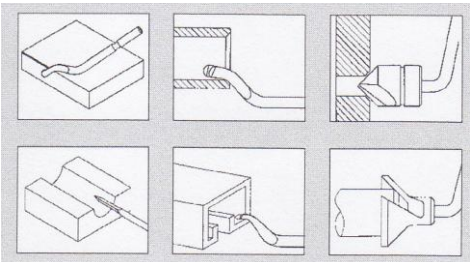

	<p>Suitable for general deburring, scraping and countersinking</p> <p>Set Contents:</p> <ul style="list-style-type: none"> 1 x RB Handle 1 x S20 Blade 1 x S10S Blade 1 x S150 Blade 1 x BC1041 Rotodrive Countersink 1 x EX2001 External Rotodrive Chamfer Blade 1 x D50 Mini Scraper Blade (modified)
---	--

Packed Weight and Dimensions

Code	Description	Weight g	W mm	H mm	L mm
SP 1010	Trouble Shooter Set	136	45	125	76

	<p>Instructions</p> <p>Do not use heavy pressure when deburring as this will cause the blade to dig into the material and give an uneven finish Use light and even pressure which will allow the blade and handle to work together to remove the burr and leave a smooth finish on the component</p> <p>Blades should be handled carefully as they are sharp and can cut Blades can break causing flying objects Sharp edges and flying objects can cause injury Users and bystanders should wear protective safety glasses Do not pry or bend blades Keep blades and sharp tools away from children Do not regrind blades as this will weaken the blade and cause breakage and possible injury</p> <p>All Noga products meet the strict requirements of ISO 9001 and ISO 14001</p>
--	---

	<p>Rapid Burr style handle Overall Length 102mm Handle Body: Painted Aluminium x 12mm hex section Blade Holder: Steel mechanism Holds all "S" type blades plus special blades with 3.2 mm mounting diameters</p>
--	--

S20 Heavy Duty Deburring Blade

	Order Code	S20				
	Pack Reference	BS2010				
	Cutting	Left and Right Hand				
	Works best on	Brass and Cast Iron				
	Used with Handle	NG-1, NG-3 + S Holder, Plastic Edge Off, Rapid Burr, Plastic Rapid Burr,				
Packed Weight and Dimensions						
Code	Pack Quantity	Weight g	Wmm	Hmm	Lmm	
S20	10	40	65	8	83	

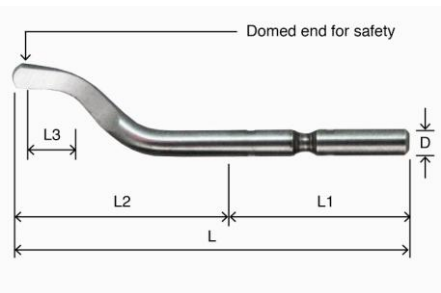
	Order Code	S20				
	Included Angle	60°				
	Blade Material	HSS M2				
	Blade Hardness	62 – 64 HRC				
	L: Overall Length	48mm				
	L1: Length Inside Handle	28mm				
	L2: Protrusion from Handle Length	20mm				
	L3: Cutting Length	6mm				
D: Shank Diameter	3.2mm					

S10S Heavy Duty Deburring Blade

	Order Code	S10S / S100				
	Pack Reference	BS1018				
	Cutting	Right Hand				
	Works best on	Stainless Steel and Plastics				
	Used with Handle	NG-1, NG-3 + S Holder, Plastic Edge Off, Rapid Burr, Plastic Rapid Burr,				
Packed Weight and Dimensions						
Code	Pack Quantity	Weight g	Wmm	Hmm	Lmm	
S10S / S100	10	40	65	8	83	

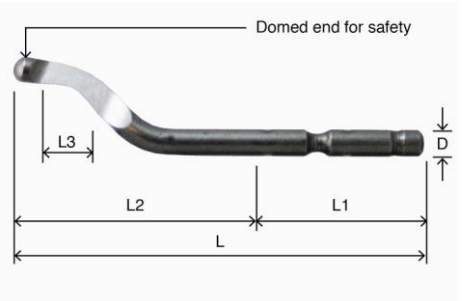
	Order Code	S10S / S100				
	Included Angle	45°				
	Blade Material	HSS Co				
	Blade Hardness	65 – 67 HRC				
	L: Overall Length	48mm				
	L1: Length Inside Handle	28mm				
	L2: Protrusion from Handle Length	20mm				
	L3: Cutting Length	6mm				
D: Shank Diameter	3.2mm					

S150 Heavy Duty Deburring Blade

	Order Code	S150			
	Pack Reference	BK3010			
	Cutting	Right Hand			
	Works best on	For holes 1.5mm and larger			
	Used with Handle	NG-1, NG-3 + S Holder, Plastic Edge Off, Rapid Burr, Plastic Rapid Burr,			
Packed Weight and Dimensions					
Code	Pack Quantity	Weight g	Wmm	Hmm	Lmm
S150	10	40	65	8	83

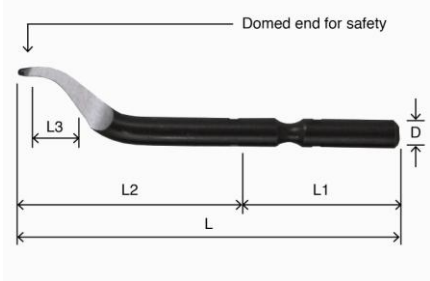
	Order Code	S150
	Included Angle	45°
	Blade Material	HSS M2
	Blade Hardness	62 – 64 HRC
	L: Overall Length	44mm
	L1: Length Inside Handle	28mm
	L2: Protrusion from Handle Length	16mm
	L3: Cutting Length	6mm
	D: Shank Diameter	3.2mm

BC 1041 Internal Rotodrive Countersink

		90° Rotodrive Countersink
		Range: 1-10.4mm diameter Blade shank diameter 3.2mm Blade material: HSS M2 Blade hardness: 62-64 HRC Used with NG-1 Handle or S Holder with NG-3 Handle

Packed Weight and Dimensions

Code	Description	Weight g	W mm	H mm	L mm
BC 1041	Rotodrive Countersink 1-10.4mm	14	36	23	71

EX 2001 External Rotodrive Chamfering Head

		<p>90° External Rotodrive Chamfer Head Range: 4 – 18mm diameter Blade shank diameter 3.2mm Blade material: HSS M2 Blade hardness: 62-64 HRC Used with NG-1 Handle or S Holder with NG-3 Handle</p>
--	---	--

Packed Weight and Dimensions

Code	Description	Weight g	W mm	H mm	L mm
EX 2001	External Chamfering Head 4-18mm	15	36	22	70

D50 Blade

	<table border="1"> <tr> <td>Order Code</td> <td>D50</td> </tr> <tr> <td>Pack Reference</td> <td>BD5010</td> </tr> <tr> <td>Cutting</td> <td>Right and Left Hand</td> </tr> <tr> <td>Works best on</td> <td>Steel, Aluminium and Plastic</td> </tr> <tr> <td>Used with Handle</td> <td>NG-3 plus D Holder, SC Handle and YT handle</td> </tr> </table> <p>Packed Weight and Dimensions</p> <table border="1"> <thead> <tr> <th>Code</th> <th>Pack Quantity</th> <th>Weight g</th> <th>Wmm</th> <th>Hmm</th> <th>Lmm</th> </tr> </thead> <tbody> <tr> <td>D50</td> <td>10</td> <td>36</td> <td>65</td> <td>9</td> <td>82</td> </tr> </tbody> </table>	Order Code	D50	Pack Reference	BD5010	Cutting	Right and Left Hand	Works best on	Steel, Aluminium and Plastic	Used with Handle	NG-3 plus D Holder, SC Handle and YT handle	Code	Pack Quantity	Weight g	Wmm	Hmm	Lmm	D50	10	36	65	9	82
Order Code	D50																						
Pack Reference	BD5010																						
Cutting	Right and Left Hand																						
Works best on	Steel, Aluminium and Plastic																						
Used with Handle	NG-3 plus D Holder, SC Handle and YT handle																						
Code	Pack Quantity	Weight g	Wmm	Hmm	Lmm																		
D50	10	36	65	9	82																		

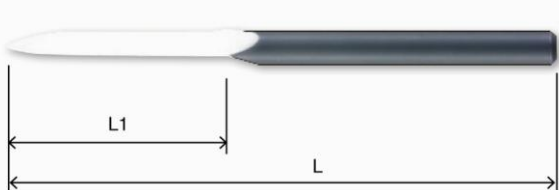
	<table border="1"> <tr> <td>Order Code</td> <td>D50</td> </tr> <tr> <td>Included Angle</td> <td>60°</td> </tr> <tr> <td>Blade Material</td> <td>HSS M2</td> </tr> <tr> <td>Blade Hardness</td> <td>62 – 64 HRC</td> </tr> <tr> <td>L: Overall Length</td> <td>50mm</td> </tr> <tr> <td>L: Cutting Length</td> <td>20mm</td> </tr> <tr> <td>D: Shank Diameter</td> <td>3.2mm</td> </tr> </table>	Order Code	D50	Included Angle	60°	Blade Material	HSS M2	Blade Hardness	62 – 64 HRC	L: Overall Length	50mm	L: Cutting Length	20mm	D: Shank Diameter	3.2mm
Order Code	D50														
Included Angle	60°														
Blade Material	HSS M2														
Blade Hardness	62 – 64 HRC														
L: Overall Length	50mm														
L: Cutting Length	20mm														
D: Shank Diameter	3.2mm														

