

NOK Oil Seal Application Guide

■ NOK Oil Seal Application Guide	E-2
1. The Selection Process	E-2
2. Allowable Operating Temperature Range	E-7

E. NOK OIL SEAL APPLICATION GUIDE

To ensure optimal performance, it is necessary to select the appropriate oil seal type and material for the actual operating conditions.

This chapter describes selection process and permissible temperature ranges for each type of oil seal listed in this catalog.

If the oil seal you need (type, material, or dimensions) is not listed in this catalog, please contact us regarding customized products.

Selection Process

Use the following steps to select your oil seal.

1. Select the Seal Type

Select the proper seal type per **Figure 1** “Flowchart for Seal Type Selection” on pages E-4 and E-5.

2. Select the Seal Lip Material

Since lip materials for catalog products should be selected according to the appropriate conditions for each oil seal type (see **Table 1** “Lip Materials by Oil Seal Type”), please refer to **Table 3** “A Guide to Permissible Working Range of Standard Oil Seals” (on pages E-6 and E-7) and **Table 4** “A Guide to Select the oil seal type in accordance with Fig. 1 “Flowchart for Seal Type Selection” on pages E4 and E5.

“A Guide to the Allowable Operating Conditions of General Oil Seals” (pages E8 to E11), as well as Chapter J “Oil and Chemical Resistance Ratings of NOK Lip Materials.”

3. Select the Metallic Materials

The metallic materials for garter springs and cases should be selected by the appropriate oil seal type, same as lip materials. **Table 2** shows the appropriate metallic materials by oil seal type. Please refer to **Table 4** “Types and Applications of Garter Spring and Case Materials (page D-7).

4. Select Seal Dimensions

Check whether the dimensions of the oil seal you want matches the shaft diameter, housing diameter, and width of the relevant area by referring to Chapter H “Type and Size List of NOK Seals.”

Please consult us before using NOK oil seals in aircraft or nuclear power equipment. The oil seals listed in this catalog are not designed nor manufactured to be used in medical equipment, and should not be used in medical equipment used for transplant surgeries or in applications that come into contact with bodily fluids or living tissue.

Materials for the oil seal lips, garter springs, and cases described in this catalog must be selected according to the applicable usage conditions for each oil seal type.

Table 1: Lip Materials by Oil Seal Type

NOK Type Designation	Shaft Diameter mm	Lip Materials																
		A727	A103	A104	A795	A134	A941	A571	A989	G418	T945	T303	S728	F585	F548	F129	31BF	31FH
S, T	Less than 150	○									○	○	○	○				
	Greater than 150						○				○	○	○	○				
TCK		○																○
V, K	Less than 150	○																
	Greater than 150						○											
TCV					○										○			
TCN					○										○			
TCZ					○										○			
T4					○													
TCJ			○									○						○
SA1, VAJ, KA3J																		○
D		○																
OC		○																
QLFY								○										
VR						○											○	
Z			○															
SBB							○											
MG			○	○														
W			○															
OKC3			○															
MO									○									
MOY										○								

Table 2: Metallic Materials by Oil Seal Type

NOK Type Designation	All types except those listed on the right	SA1J, VAJ, KA3J
Garter Spring	JIS G3521 SW JIS G3522 SWP	JIS G4309 SUS304
Metal Case	JIS G3141 SPCC JIS G3131 SPHC	JIS G4305 SUS304 JIS G4307 SUS304



Flowchart for Seal Type Selection

Figure 1: Flowchart for Seal Type Selection (For the features of each oil seal type, refer to pages C-3, C-4, and C-5.)

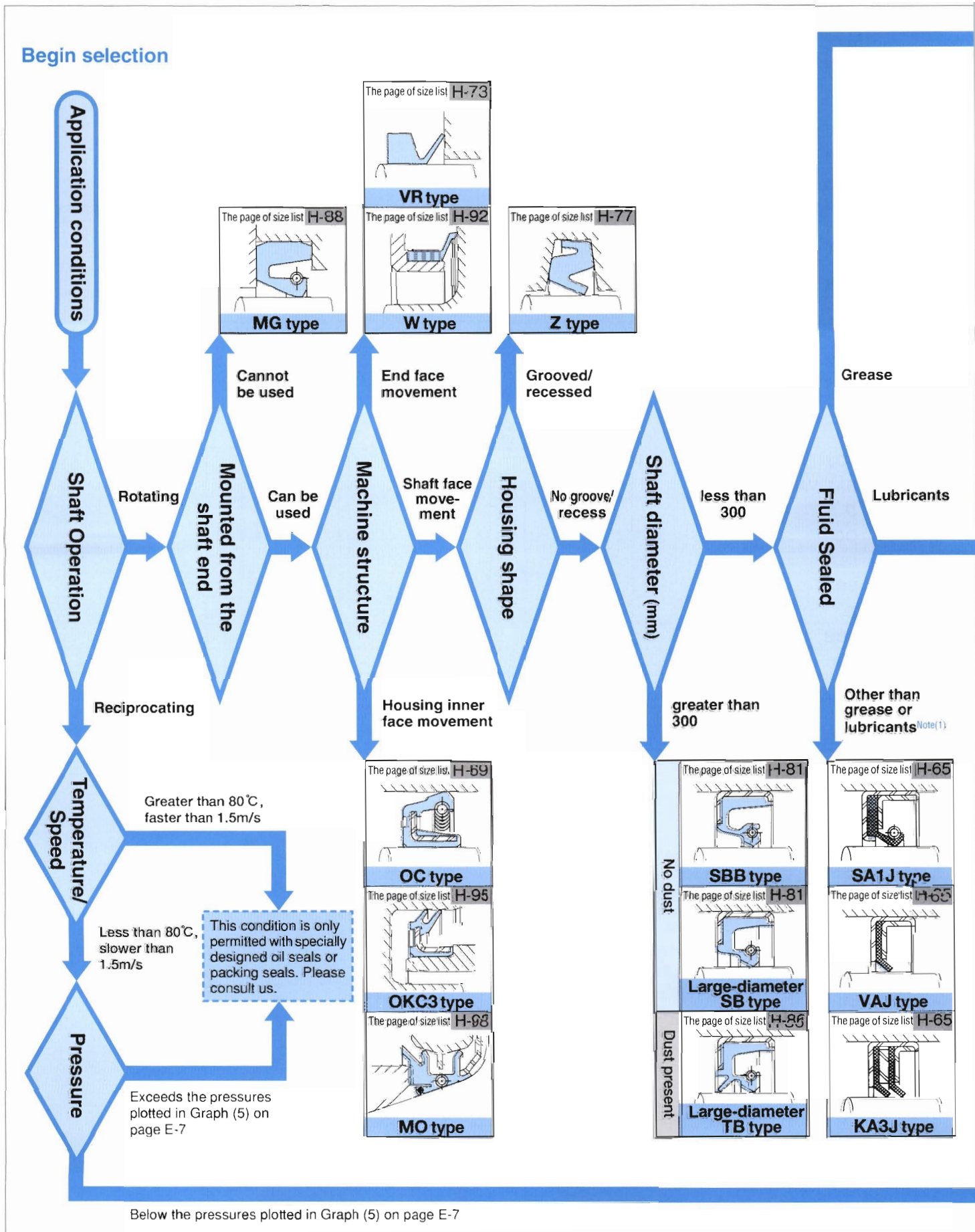

E

- Note(1):** You may select any oil seal type, other than SA1J, VAJ and KA3J, depending on the type of fluid sealed (brake oil, gasoline, kerosene, light oil, heavy oil, cutting oil, or water or chemical fluid). Please consult us.
- Note(2):** When the housing material is a light alloy or resin having a large coefficient of thermal expansion, select a seal with a rubber exterior. For other housings, you may select either a rubber or metal exterior design.
- Note(3):** When you cannot make a selection from this flowchart for other application conditions (such as vacuum or negative pressure), please consult us.
- Note(4):** When you have to choose D type due to constrain spaces, please consult us by showing your application condition.

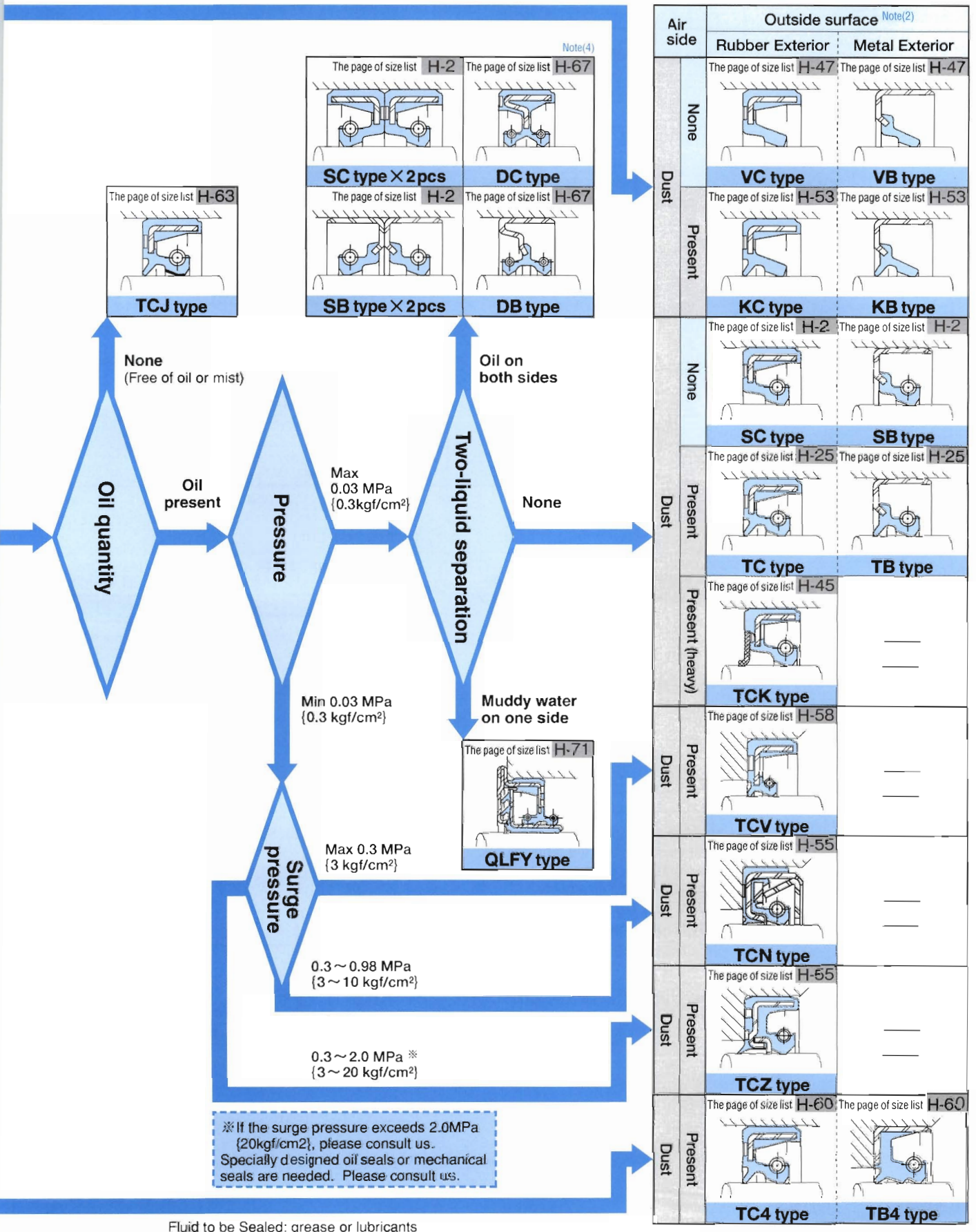



E

A Guide to Allowable Operating Conditions

Note (1): The working ranges listed are a general guide based on the general seal shape and material, and may vary with actual working environments or seal designs. For use at higher linear shaft velocities, higher pressures, or higher/lower temperature regions than shown here, please consult us.

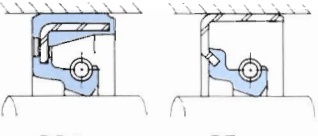
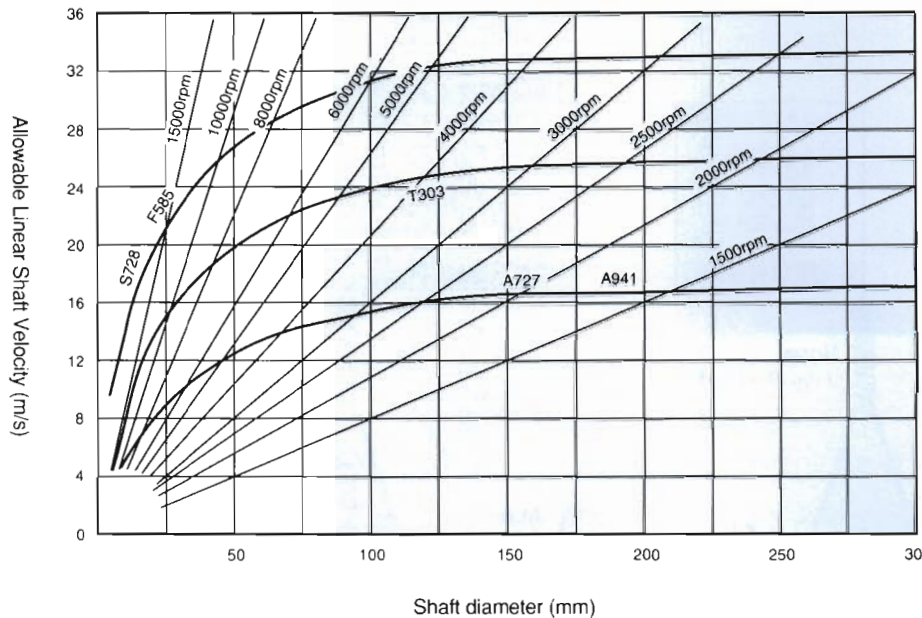
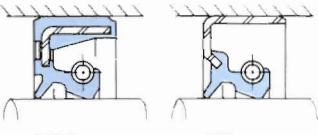
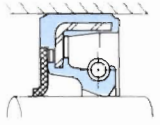
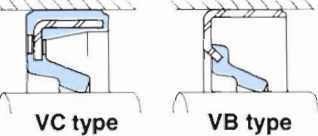
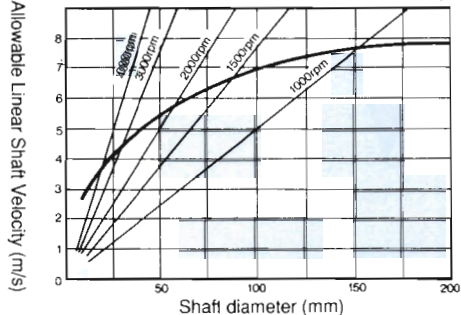
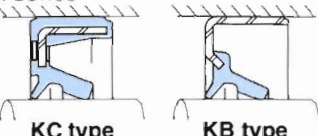
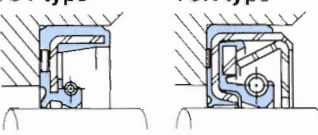
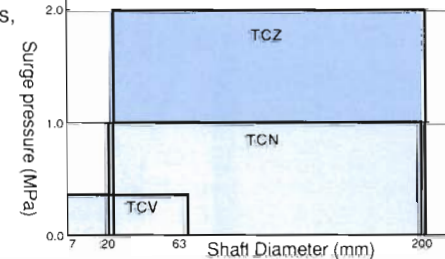
Table 3: A Guide to Allowable Operating Conditions of Standard Oil Seals

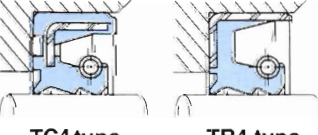
NOK Seal Type	Item	Linear Shaft Velocity (m/s)
S series	 <p>SC type SB type</p>	<p>Use a linear shaft velocity within the permissible range plotted in Graph (1).</p> <p>Graph (1): Shaft Diameter vs. Maximum Allowable Linear Shaft Velocity</p> 
T series	 <p>TC type TB type</p>	
New fabric seal	 <p>TCK type</p>	
V series	 <p>VC type VB type</p>	<p>Use a linear shaft velocity within the permissible range plotted in Graph (2).</p> <p>Graph (2): Shaft Diameter vs. Maximum Allowable Linear Shaft Velocity.</p> 
K series	 <p>KC type KB type</p>	
TCV type TCN type		<p>Use the average normal pressure and average linear shaft velocity within the range plotted in Graph (3). For momentary peak pressure (surge pressure) limits, use the following as a guide.</p> <p>TCV type: 0.3 MPa (3kgf/cm²) TCN type: 0.98 MPa (10 kgf/cm²) TCN type: 2.0 MPa (20 kgf/cm²)</p> <p>Graph (3): Surge pressure limits of TCV, TCN and TCZ type oil seals</p> 
TCZ type		
T4 type	 <p>TC4 type TB4 type</p>	<p>Linear shaft velocity must be 1.5 m/s or less.</p>

E

Note(2): The environmental temperature limits will vary depending on the type of rubber, oil, or linear shaft velocities. Generally, the limiting environmental temperature is as specified in the column "Environmental Temperature(°C)" in the table below. For details of the allowable operating temperature of various lip materials, see the section beginning on page E-12.

Note(3): For the average operating life of oil seals, refer to Fig. 5 on page J-4.

Note(4): For the definitions of shaft-to-bore misalignment and dynamic shaft run-out, refer to Fig. 2 on page E-9.

Explanation of terms under the column "Environmental Temperature"

Maximum Temperature: The temporary peak maximum temperature

Maximum Normal Temperature: The maximum temperature within the normal service temperature range, except for momentary peak temperatures.

Normal Temperature: The temperature at which the oil seal is most frequently used.

Minimum Temperature: The lowest temporary temperature

Pressure (MPa)	Environment Temperature (°C)	Maximum Allowable Total Shaft Run-out																													
		Shaft-to-Bore Misalignment ^(Note)	Shaft Dynamic Run-out ^(Note)																												
<p>(1) The maximum pressure limit is 0.03 MPa (0.3 kgf/cm²).</p> <p>(2) When the lip material is nitrile rubber or fluoro-carbon rubber and the shaft diameter is less than 30 mm, a pressure higher than 0.03 MPa (kgf/cm²) is allowed.</p>	<table border="1"> <thead> <tr> <th>Lip Material</th> <th>Maximum Normal Temperature</th> <th>Normal Temperature</th> <th>Minimum Temperature</th> </tr> </thead> <tbody> <tr> <td>A727</td> <td>100</td> <td>80</td> <td>-30</td> </tr> <tr> <td>A941</td> <td>80</td> <td>70</td> <td>-25</td> </tr> <tr> <td>T303</td> <td>130</td> <td>110</td> <td>-15</td> </tr> <tr> <td>T945</td> <td>140</td> <td>120</td> <td>-37</td> </tr> <tr> <td>S728</td> <td>150</td> <td>130</td> <td>-45</td> </tr> <tr> <td>F585</td> <td>170</td> <td>150</td> <td>-15</td> </tr> </tbody> </table>	Lip Material	Maximum Normal Temperature	Normal Temperature	Minimum Temperature	A727	100	80	-30	A941	80	70	-25	T303	130	110	-15	T945	140	120	-37	S728	150	130	-45	F585	170	150	-15	<p>Total Run-out is expressed as the sum of the shaft-to-bore misalignment and shaft dynamic run-out. The permissible total shaft run-out vs. shaft diameters is plotted in Graph (6). Make sure that the sum of these off-centers (i.e., the total run-out) does not exceed the permissible range in Graph (6).</p> <div style="border: 1px solid black; padding: 5px; width: fit-content;"> <p>Total Shaft Run-out = dynamic shaft run-out + [shaft-to-bore misalignment × 2]</p> <p style="font-size: small;">(mm TIR) (mm)</p> </div> <p>Note(1): "TIR" means total indicator reading. Note(2): Since only the center-to-center offset is measured, the total shaft-to-bore run-out is twice as much as the center-to-center measurement.</p> <p>(Example) Since the permissible total run-out is 0.35 mm TIR for a shaft diameter of 50mm running at 2000 rpm, insure that the shaft-to-bore misalignment is 0.25mm TIR or less if the shaft dynamic run-out is a maximum of 0.1mm TIR.</p> <p>Graph(6): Maximum Allowable Total Shaft Run-out vs. Shaft Diameter</p>	
Lip Material	Maximum Normal Temperature	Normal Temperature	Minimum Temperature																												
A727	100	80	-30																												
A941	80	70	-25																												
T303	130	110	-15																												
T945	140	120	-37																												
S728	150	130	-45																												
F585	170	150	-15																												
<p>V and K type oil seals cannot be used where pressure is applied.</p>	<table border="1"> <thead> <tr> <th>Lip Material</th> <th>Maximum Normal Temperature</th> <th>Normal Temperature</th> <th>Minimum Temperature</th> </tr> </thead> <tbody> <tr> <td>A727</td> <td>100</td> <td>80</td> <td>-30</td> </tr> <tr> <td>A941</td> <td>80</td> <td>70</td> <td>-25</td> </tr> </tbody> </table>	Lip Material	Maximum Normal Temperature	Normal Temperature	Minimum Temperature	A727	100	80	-30	A941	80	70	-25	<p>Insure that the total shaft run-out is within the permissible range plotted in Graph (7).</p> <p>Graph(7): Maximum Allowable Total Shaft Run-out vs. Shaft Diameter</p>																	
Lip Material	Maximum Normal Temperature	Normal Temperature	Minimum Temperature																												
A727	100	80	-30																												
A941	80	70	-25																												
<p>Use the average normal pressure and average linear shaft velocity within the range plotted in Graph (4).</p> <p>Graph(4): Allowable Operating range of TCV, TCN and TCZ type oil seals</p>	<table border="1"> <thead> <tr> <th>Lip Material</th> <th>Maximum Normal Temperature</th> <th>Normal Temperature</th> <th>Minimum Temperature</th> </tr> </thead> <tbody> <tr> <td>A795</td> <td>70</td> <td>60</td> <td>-11</td> </tr> <tr> <td>F548</td> <td>150</td> <td>120</td> <td>-16</td> </tr> </tbody> </table>	Lip Material	Maximum Normal Temperature	Normal Temperature	Minimum Temperature	A795	70	60	-11	F548	150	120	-16	0.1mm TIR or less	0.05mm TIR or less																
Lip Material	Maximum Normal Temperature	Normal Temperature	Minimum Temperature																												
A795	70	60	-11																												
F548	150	120	-16																												
<p>Use a pressure within the permissible range plotted in Graph (5).</p> <p>Graph(5): Maximum Allowable Pressure vs. Shaft Diameter</p>	<table border="1"> <thead> <tr> <th>Lip Material</th> <th>Maximum Normal Temperature</th> <th>Normal Temperature</th> <th>Minimum Temperature</th> </tr> </thead> <tbody> <tr> <td>A795</td> <td>80</td> <td>70</td> <td>-11</td> </tr> </tbody> </table>	Lip Material	Maximum Normal Temperature	Normal Temperature	Minimum Temperature	A795	80	70	-11	0.2mm TIR or less																					
Lip Material	Maximum Normal Temperature	Normal Temperature	Minimum Temperature																												
A795	80	70	-11																												



A Guide to Allowable Operating Conditions of General Oil Seals

Table 4-1: A Guide to Allowable Operating Conditions of General Oil Seals

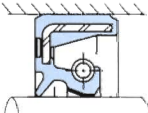
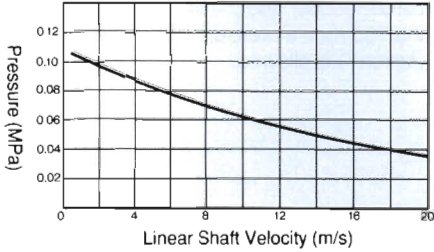
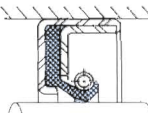
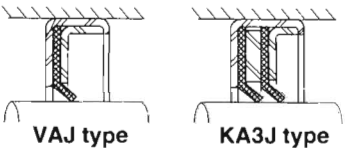
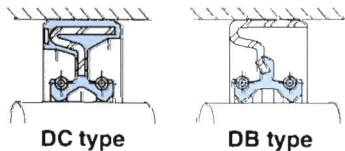
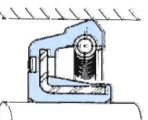
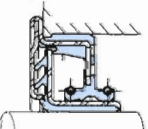
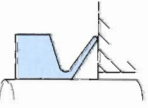
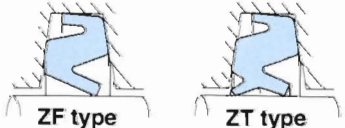
NOK Seal Type	Item	Lip Material			Allowable Operating Conditions	
		Material Family Type	NOK Material Code	Hardness (DurometerA)	Linear Shaft Velocity (m/s)	Pressure (MPa)
J type (PTFE)  TCJ type		Nitrile Rubber (NBR)	A103+31BF	70	Graph (8): Maximum Allowable Pressure vs. Linear Shaft Velocity 	
		Acrylic Rubber (ACM)	T303+31BF	70		
 SA1J type		Tetrafluoroethylene resin (PTFE)	31BF	65 Durometer D	15 or less	max0.3 {max3kgf/cm ² }
 VAJ type KA3J type					5 or less	max0.1 {max1kgf/cm ² }
D series  DC type DB type		Nitrile Rubber (NBR)	A727	70	10 or less	max0.03 or less {max0.3kgf/cm ² }
		Acrylic Rubber (ACM)	T303	80	15 or less	
OC type 		Nitrile Rubber (NBR)	A727	70	10 or less	max0.03 or less {max0.3kgf/cm ² }
QLFY type (Unitized seal) 		Nitrile Rubber (NBR)	A571	75	2 or less	max0.03 {max0.3kgf/cm ² }
VR type (End face seal) 		Nitrile Rubber (NBR)	A134	60	10 or less	Cannot be used where pressure is applied.
		Fluorocarbon Rubber (FKM)	F129	70		
Z series  ZF type ZT type		Nitrile Rubber (NBR)	A103	70	3 or less	Cannot be used where pressure is applied.

E

Allowable Operating Conditions

Environmental temperature (°C)

Total Run-out (mm TIR)

Lip Material	Maximum Normal Temperature	Normal Temperature	Minimum Temperature
A103	80	70	-22
T303	130	110	-15

Shaft diameter (d)	Total run-out
$< d \leq 40$	0.2
$40 < d \leq 80$	0.3
$80 < d \leq 120$	0.4

Lip Material	Maximum Normal Temperature	Normal Temperature	Minimum Temperature
31BF	200	180	-50

Shaft diameter (d)	Total run-out
$< d \leq 40$	0.15
$40 < d \leq 80$	0.2
$80 < d \leq 120$	0.25
$120 < d \leq 200$	0.3
$200 < d \leq 300$	0.35

Lip Material	Maximum Normal Temperature	Normal Temperature	Minimum Temperature
A727	80	60	-30
T303	100	80	-15

Shaft diameter (d)	Total run-out
$< d \leq 40$	0.3
$40 < d \leq 80$	0.4
$80 < d \leq 120$	0.5

Lip Material	Maximum Normal Temperature	Normal Temperature	Minimum Temperature
A727	100	80	-30

Shaft diameter (d)	Total run-out
$< d \leq 40$	0.25
$40 < d \leq 80$	0.3
$80 < d \leq 120$	0.4
$120 < d \leq 200$	0.5

Lip Material	Maximum Normal Temperature	Normal Temperature	Minimum Temperature
A571	80	70	-25

0.35 or less

Lip Material	Maximum Normal Temperature	Normal Temperature	Minimum Temperature
A134	80	70	-20
F129	150	120	-15

—

Lip Material	Maximum Normal Temperature	Normal Temperature	Minimum Temperature
A103	80	70	-22

0.3 or less

Figure 2: Shaft-to-Bore Misalignment and Shaft Dynamic Run-out

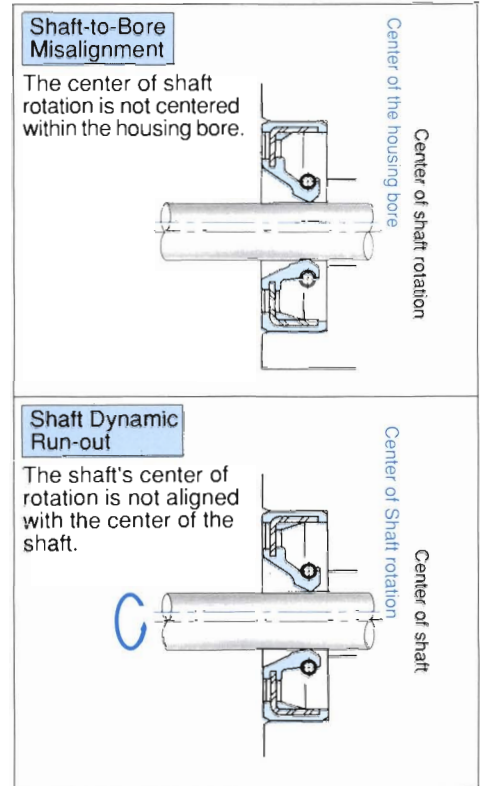

A Guide to Allowable Operating Conditions of General Oil Seals

Table 4-2: A Guide to Allowable Operating Conditions of General Oil Seals

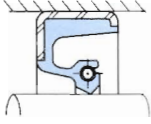
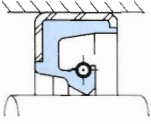
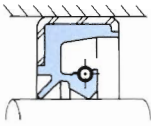
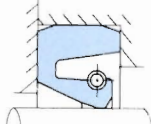
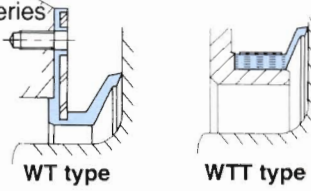
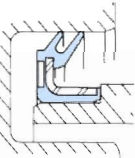
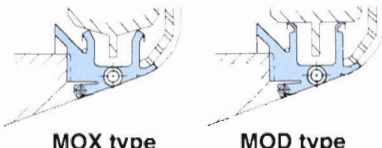
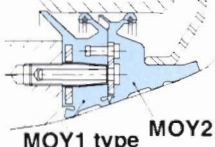
Item NOK Seal Type	Lip Material			Allowable Operating Conditions		
	Material Family Type	NOK Material Code	Hardness (Durometer A)	Linear Shaft Velocity (m/s)	Pressure (MPa)	
SBB type 	Nitrile Rubber (NBR)	A941	80	25 or less	max0.03 {max0.3kgf/cm ² }	
Large-diameter SB type 				15 or less		
Large-diameter TB type 						
MG type 		Lip: A103 (Exterior Surface: A992)	70 (90)	5 or less		Cannot be used where pressure is applied.
		A104	80			
Wseries 			A103	70		15 or less
OKC3 type 						
MO type (Morgoil) 		A989	70	25 or less	max0.03 {max0.3kgf/cm ² }	
MOY type (Meseta seal) 	Hydrogenated Nitrile Rubber (HNBR) Nitrile Rubber (NBR)	Lip: G418 (Static Area: A989)	75 (70)	25 or less		

E

Allowable Operating Conditions

Environmental temperature (°C)

Total Run-out (mm TIR)

Lip Material	Maximum Normal Temperature	Normal Temperature	Minimum Temperature
A941	80	70	-25

Shaft diameter (d)	Total run-out
300 < d ≤ 500	0.4
500 < d ≤ 700	0.6
700 < d ≤ 1200	0.8
1200 < d ≤ 2000	1

Shaft diameter (d)	Total run-out
300 < d ≤ 500	0.6
500 < d ≤ 630	1.0
630 < d ≤ 1000	1.6
1000 < d ≤ 2000	2.2

0.2 or less

Lip Material	Maximum Normal Temperature	Normal Temperature	Minimum Temperature
A103	80	70	-22
A104			-21

Lip Material	Maximum Normal Temperature	Normal Temperature	Minimum Temperature
A989	80	70	-25

2.5D/1000
D = oil seal outer diameter (mm)

Lip Material	Maximum Normal Temperature	Normal Temperature	Minimum Temperature
G418	110	90	-25

Figure 2: Shaft-to-Bore Misalignment and Shaft Dynamic Run-out

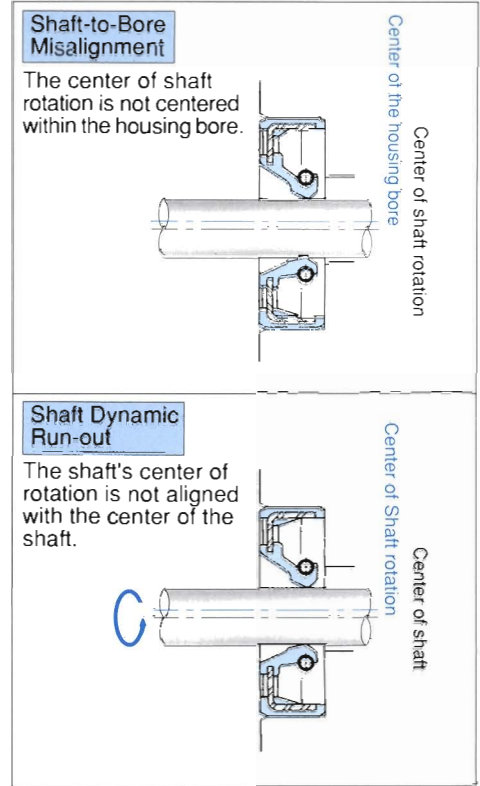

Allowable Temperature Range

Pages E-7 through E-12 describe the allowable temperature ranges for various lip materials. Note that the actual temperature limitations may vary in accordance with such factors as the type of fluid sealed or usage time. Therefore, it is necessary to consider these factors when selecting a lip material.

Temperature limitations for the S-type oil seal, which is a typical oil seal, are summarized for your reference. Please note that the temperature at the lip of the T type seal rises twice as much as the S type, and that the temperature rise of the V and K types is the same as that of the S type.

To select the proper lip material for an oil seal, it is necessary to estimate the approximate temperature at the seal lip edge of the oil seal (T_0). This temperature can be estimated by determining the maximum normal temperature of the fluid near the oil seal (T_1), and the increased underlip temperature generated by the friction between the shaft and lip (T_2). (Refer to Fig. 3.) The temperature at the sealing edge (T_0) can be given by the expression (1) below.

$$T_0 = T_1 + T_2 \quad \dots\dots(1)$$

- T_0 : Temperature at the seal lip edge
- T_1 : Temperature of sealed fluid nearest to the oil seal (maximum normal temperature)
- T_2 : Friction-generated heat

A suitable lip material needs to be selected based on the temperature of the seal lip edge and the type of sealed fluid, and it is necessary to select a material within the upper limit of the maximum allowable temperature (T) for the lip materials shown in Table 5 on page E-15.

The permissible temperature of a lip material varies with the operating conditions of the actual equipment used.

Table 5 shows an example in which the usage time at the maximum normal temperature is within 30% of the total operating time. Thus, if the working time at the maximum normal temperature exceeds 30% of the total operating time, reduce the permissible temperature (T) by 20 °C.

For gear oil or high-viscosity silicone oil, the friction-generated heat at the lip (T_2) is 1.5 times the value shown in Fig. 3. For grease, the friction-generated heat at the lip is 3 times that shown in Fig. 3.

Figure 3: A Guide to the Friction-Generated Heat at the Seal Lip (S type)

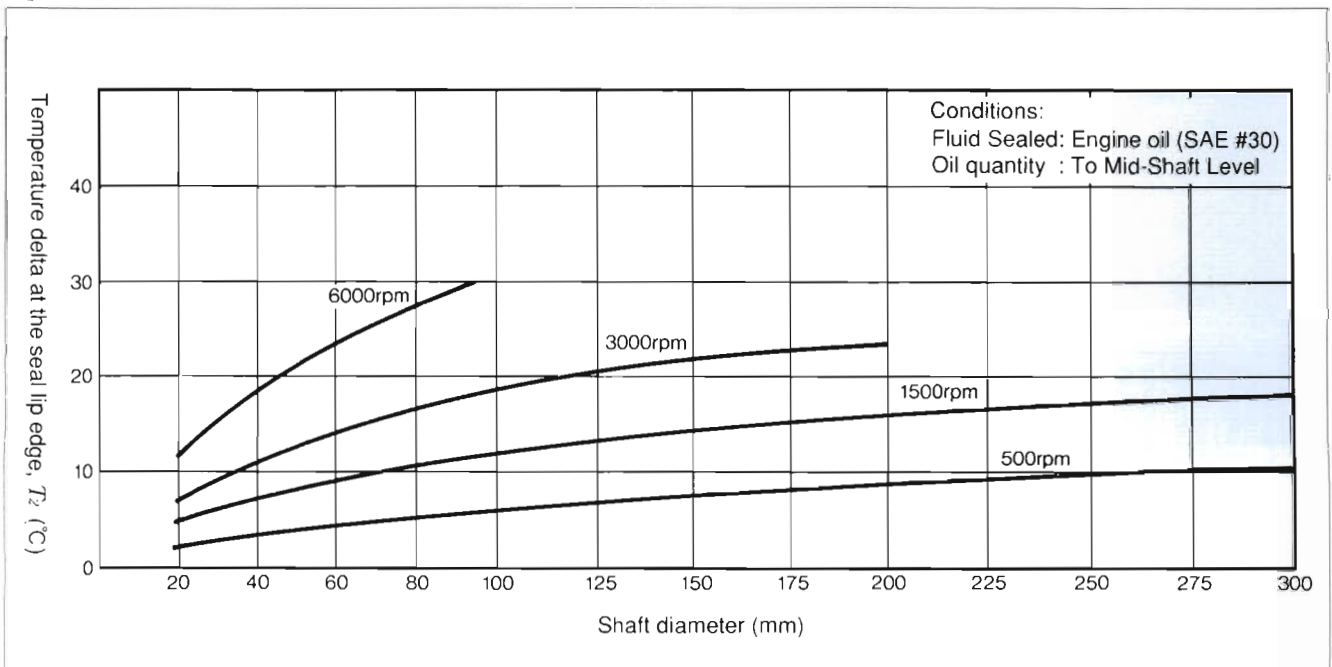

If the usage time at the maximum normal temperature exceeds 30% of the total working time, reduce the allowable temperature by 20 °C (T-20 °C)

Table 5: Allowable Operating Temperature Ranges of Various Lip Materials in S-Type Oil Seals

Types of Fluid to be Sealed		Allowable operating temperature of the lip material (maximum temperature) T(°C)																		
		40	50	60	70	80	90	100	110	120	130	140	150	160	170	180	190	200		
Engine oil	SAE #30			A727										S728						
		A941																		
	SAE10W-#30	A727																		
		A941																		
Gear oil	Vehicles	A727																		
		A941									T303			F585						
	Hypoid gears	A727																		
		A941																		
Torque converter oil Automatic transmission fluid				A727																
				A941																
Brake Fluid	DOT 3 (glycol base)			(E188)				(E747)												
	DOT 5 (glycol base)			Styrene-butadiene rubber				Ethylene-propylene rubber												
	DOT 5 (silicone base)			A727																
Turbine oil	Class 2	A727																		
		A941																		
Machine oil (No.2 spindle oil)		A727																		
			A941																	
Hydraulic fluid (mineral oil base)			A727													F585				
			A941																	
Grease	Mineral oil based	A727										T303								
		A941																		
	Silicone based	A727																		
		A941												F585						
	Fluorine based	A727																		
		A941																		
Gasoline																				
Light oil, kerosene		A795		F585																
Heavy oil				A795																
		A941																		

Note(1): Only the maximum value of the allowable temperature is used.

Note(2): The heat resistance of the fluid sealed must be greater than the lip material's resistance.

Note(3): A727 (for a shaft diameter of 150 mm or smaller) and A941 (for a shaft diameter of 150 mm or larger) are standard materials.

Note(4): The lip materials shown in parentheses are NOK's non-standard materials.

Note(5): For sealing solutions not shown in the table, see pages J-7 through J32.

Note(6): The cost guide for each material is shown on the right.

Note(7): For water-based hydraulic fluid (water + emulsion base or water + glycol base), synthetic fluid based grease, and other oils (ester oil, glycol oil), please consult us. It is necessary to confirm that these oils are suitable for use.

Lip Material Type	Cost
Nitrile rubber	Less expensive ↑ ↓ More expensive
Acrylic rubber	
Silicone rubber	
Fluorocarbon rubber	
Tetrafluoroethylene resin (PTFE)	